

Epson Stylus® CX5800F



Basics Guide

Basic Copying, Printing, Faxing, and Scanning
Maintaining Your Epson Stylus CX5800F
Solving Problems

Copyright Notice

All rights reserved. No part of this publication may be reproduced, stored in a retrieval system, or transmitted in any form or by any means, electronic, mechanical, photocopying, recording, or otherwise, without the prior written permission of Seiko Epson Corporation. The information contained herein is designed only for use with this Epson product. Epson is not responsible for any use of this information as applied to other equipment.

Neither Seiko Epson Corporation nor its affiliates shall be liable to the purchaser of this product or third parties for damages, losses, costs, or expenses incurred by purchaser or third parties as a result of: accident, misuse, or abuse of this product or unauthorized modifications, repairs, or alterations to this product, or (excluding the U.S.) failure to strictly comply with Seiko Epson Corporation's operating and maintenance instructions.

Seiko Epson Corporation shall not be liable for any damages or problems arising from the use of any options or any consumable products other than those designated as Original Epson Products or Epson Approved Products by Seiko Epson Corporation.

Responsible Use of Copyrighted Materials

Digital cameras, scanners, and ink jet printers, like conventional photocopiers and cameras, can be misused by improper copying or printing of copyrighted material. While some countries' laws permit limited copying of copyrighted material in certain circumstances, those circumstances may not be as broad as some people assume. Epson encourages each user to be responsible and respectful of the copyright laws when using digital cameras, scanners, and ink jet printers.

Trademarks

Epson and Epson Stylus are registered trademarks and Exceed Your Vision is a trademark of Seiko Epson Corporation.

Epson Connection, Epson Store, and SoundAdvice are service marks of Epson America, Inc.

USB DIRECT-PRINT™ and the USB DIRECT-PRINT logo are trademarks of Seiko Epson Corporation. Copyright © 2002 Seiko Epson Corporation. All rights reserved.

DPOF™ is a trademark of CANON INC., Eastman Kodak Company, Fuji Photo Film Co., Ltd. and Matsushita Electric Industrial Co., Ltd.



SD™ is a trademark.

Memory Stick, Memory Stick Duo, Memory Stick PRO, and Memory Stick PRO Duo are trademarks of Sony Corporation.



xD-Picture Card™ is a trademark of Fuji Photo Film Co.,Ltd.

General Notice: Other product names used herein are for identification purposes only and may be trademarks of their respective owners. Epson disclaims any and all rights in those marks.

© 2005 Epson America, Inc. 9/05

Contents

Introduction	5
Selecting a Different Control Panel Language	6
Loading Paper	7
Copying a Photo or Document	9
Placing the Original on the Glass	9
Copying	11
Printing From a Memory Card or Camera	15
Compatible Cards and Image Formats	16
Inserting the Card	17
Printing an Index Sheet to Select Photos	18
Printing All Photos or DPOF Photos	21
Printing From a Digital Camera	22
Printing From Your Computer	23
Printing in Windows	23
Printing With Macintosh OS X	26
Using Special Papers	29
Faxing a Photo or Document	31
Connecting a Phone or Answering Machine	31
Setting Up Your Fax Features	32
Sending a Fax	39
Receiving a Fax	41
Scanning a Photo or Document	43
Basic Scanning	43
Restoring Color in Faded Photos	45

Maintaining Your Epson Stylus CX5800F	47
Checking the Print Head Nozzles	47
Cleaning the Print Head	48
Checking the Ink Levels	49
Replacing Ink Cartridges	50
Solving Problems	55
Error Messages	55
Problems and Solutions	57
Where To Get Help	60
Notices	61
Index	69

Introduction

After you have set up your Epson Stylus® CX5800F all-in-one as described on the *Start Here* sheet, turn here to:

- Load paper
- Make a quick copy of a document or photo
- Print photos stored on a memory card
- Print photos directly from your camera
- Print a basic document or photo from your computer
- Fax a document or photo
- Scan a document or photo, including restoring a color photo as you scan
- Perform routine maintenance
- Solve simple problems

This book tells you how to do most of these things without ever turning on your computer! Of course your Epson Stylus CX5800F can do lots more when you connect it to your Windows® or Macintosh® computer. For additional instructions, see the on-screen *User's Guide* by selecting the icon for it on your desktop.

Please follow these guidelines as you read your Epson Stylus CX5800F instructions:

Warning:

Warnings must be followed carefully to avoid bodily injury.

Caution:

Cautions must be observed to avoid damage to your equipment.

Note:



Notes contain important information about your Epson Stylus CX5800F.

Tip:

Tips contain hints for better copying, scanning, printing, and faxing.

Selecting a Different Control Panel Language

If you prefer to view messages on the Epson Stylus CX5800F display in a language other than English, follow these steps:

1. Press the  **On** button to turn on the Epson Stylus CX5800F, or press the  **Cancel/Back** button until you see a screen like this:

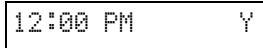

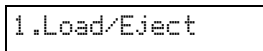

12:00 PM Y

2. Press the **Setup** button. You see this display:



1.Load/Eject

3. Press the  or  button, or press the 7 key on the numeric keypad, to display this option:

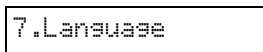

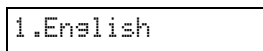

7.Language

4. Press the **OK** button. You see a display like this:



1.English

5. Press the  or  button as necessary to select **Español**, **Français**, or **English**.
6. Press the **OK** button.
7. Press the  **Cancel/Back** button until you return to the first screen.

Loading Paper

Follow the steps here to load paper in your Epson Stylus CX5800F all-in-one.

1. Open the paper support and output tray, then slide out the extensions.
2. Flip the feeder guard forward. Then slide the left edge guide to the left.

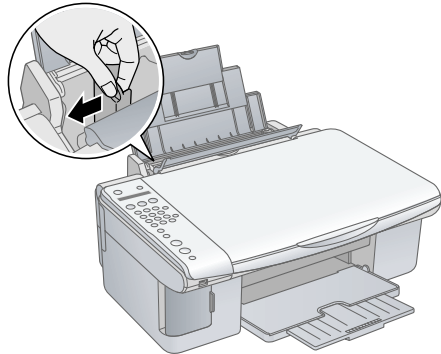
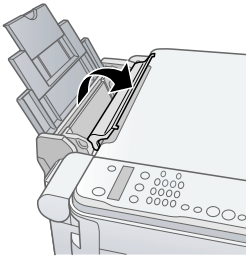
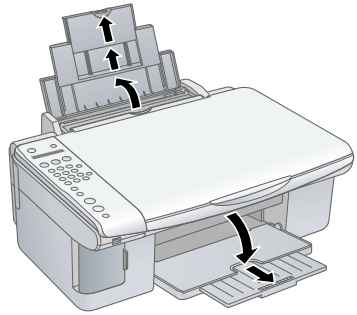

3. Insert the paper, printable side up, against the right edge guide. Always load it short edge first, even for landscape printing.

The printable side is often whiter or brighter than the other side.

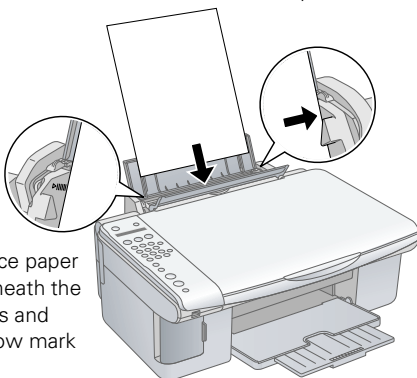

Place paper beneath the tabs and arrow mark

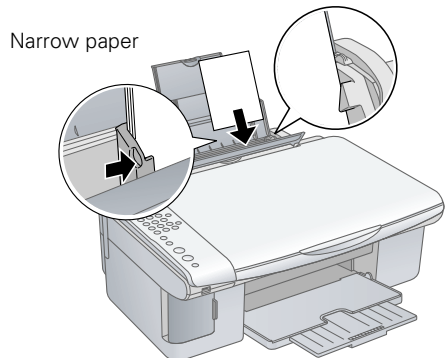



You can load up to 100 sheets of 17 lb plain paper or up to 20 sheets of photo paper. See the *User's Guide* for capacity guidelines on other paper types.

Note:

The type of paper you choose affects the way your printout looks, so be sure to select the correct paper for your job. If you are just making a copy or printing a rough draft of an image, plain paper is fine. However, for the best results, you'll want to use one of Epson's special ink jet papers designed for your printer. For example, your photos will look great printed on Epson Premium Glossy Photo Paper. See page 29 for details.

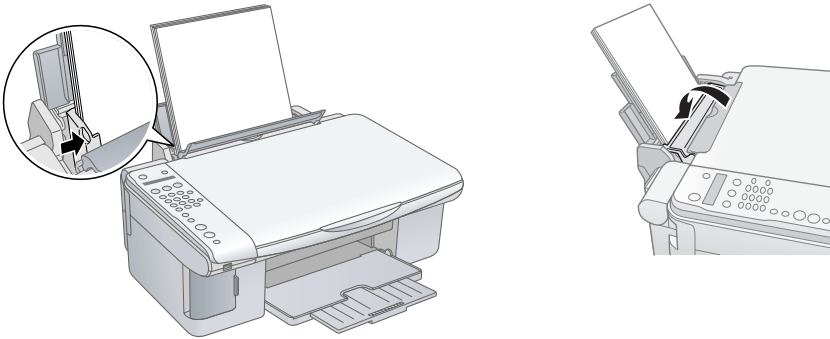
4. Slide the left edge guide against the left edge of the paper (but not too tightly). Then flip the feeder guard back.



5. Make sure the paper thickness lever is set down to the  L position.

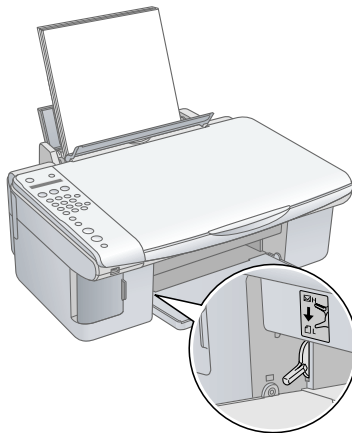

Copying a Photo or Document

Follow the instructions in this section to:

- Position your photo or document correctly on the glass (see below)
- Make copies of a photo or document (on page 11)

Placing the Original on the Glass

1. Open the document cover and place your original face-down on the glass, in the upper left corner. Move your original about 0.04 inch (1 mm) away from the top and left edges so all of it will be copied.

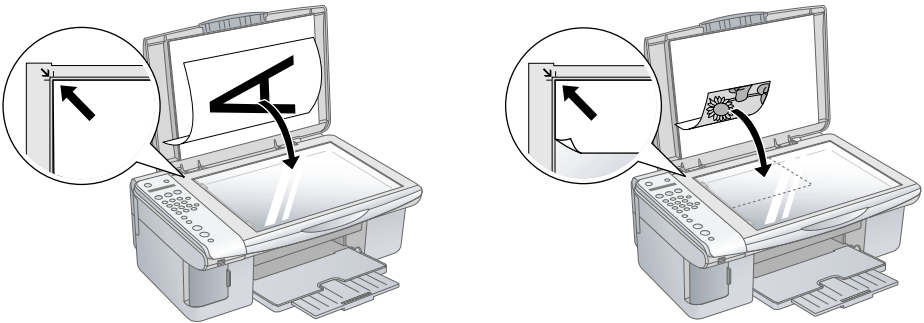

Move the original about 0.04 inch (1 mm) away from the top and left edges to avoid cropping

2. Close the document cover gently so you don't move the original.

Caution:

Never open the document cover beyond where it stops and do not place heavy objects on top of the Epson Stylus CX5800F all-in-one.

If you need to copy or scan a thick or large document, you can remove the document cover. Just open it and pull it straight up.

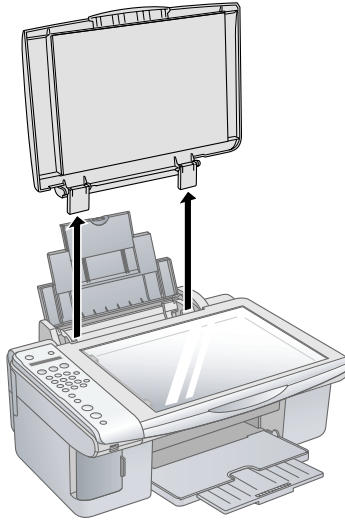

If you need to press the document flat while you copy or scan it, do not press too hard and be careful not to move it.

Caution:





Do not use excessive force on the document cover, and do not twist it. You may damage the document cover.

When you are done, replace the document cover by inserting the tabs back into the slots.

Copying

You can make copies using either letter-size (8.5 × 11-inch) plain paper, or letter-size, 4 × 6-inch, or 5 × 7-inch photo paper.

Copying a Document

1. Press the  **On** button to turn on the Epson Stylus CX5800F. You see a screen like this: 
2. Place the document on the glass as described on page 9. Be sure to close the document cover.
3. Load up to 100 sheets of letter-size plain paper. See page 7 for details.
4. Press the **Copy** button. You see this display: 
5. If you want your copies automatically reduced or enlarged to fit the loaded paper size (Fit to Page mode), press the **Copy** button again. The display changes to this: 
6. To make multiple copies (up to 99), press the number keys on the numeric keypad. The display shows the number you select.

Note:

If you need to cancel the number of copies selected, press the  **Cancel/Back** button. To exit Copy mode, press the  **Cancel/Back** button again.

7. Press the paper type button to select **Plain Paper**. The light indicates which type is selected.
8. Press the paper size button to select **Letter**.
9. To make a color copy, press the  **Start Color** button.

To make a black and white copy, press the  **Start B&W** button.





Printing appears on the display and the Epson Stylus CX5800F starts copying.

If you need to stop copying, press the  **Cancel/Back** button. Do not pull out paper that is being printed; it will be ejected automatically to the output tray.

Note:

The copies may not be exactly the same size as the original.

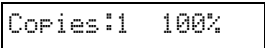
Copying a Photo

1. Press the  **On** button to turn on the Epson Stylus CX5800F. You see a screen like this: 
2. Place the photo on the glass as described on page 9. Be sure to close the document cover.
3. Load up to 20 sheets of letter-size, 4 × 6-inch, or 5 × 7-inch photo paper. See page 7 for details.
4. Press the **Copy** button. You see this display: 
5. If you want borderless photos (printed without a white border), press the **Copy** button again to select **Fit to Page** mode. (If you select **100%**, photos are printed with a 0.12-inch [3 mm] border.) The display changes to this: 
6. To make multiple copies (up to 99), press the number keys on the numeric keypad. The display shows the number you select.

Note:

If you need to cancel the number of copies selected, press the  **Cancel/Back** button. To exit Copy mode, press the  **Cancel/Back** button again.

7. Press the paper type button to select **Photo Paper**.
8. Press the paper size button to select **Letter, 4"×6"**, or **5"×7"**.
9. To make a color copy, press the  **Start Color** button.

To make a black and white copy, press the  **Start B&W** button.

Printing appears on the display and the Epson Stylus CX5800F starts copying.

If you need to stop copying, just press the  **Cancel/Back** button. Do not pull out paper that is being printed; it will be ejected automatically to the output tray.

Note:

The copies may not be exactly the same size as the original.

When making a lot of copies, it is a good idea to remove the printed copies from the output tray after every 10 sheets or so.

Speeding Up Copying

If you want to make a copy quickly and do not need high quality, you can print a “draft” copy. The print quality is reduced, but the copy is printed faster.

1. Load plain, letter-size paper.
2. Press the **Copy** button. You see this display:

Copies:1	100%
----------	------
3. Press the paper type button to select **Plain Paper**.
4. Press the paper size button to select **Letter**.
5. Hold down the **Cancel/Back** button, then press the **Start Color** button (to copy in color) or the **Start B&W** button (to copy in black and white). When **Color Draft Mode** or **B/W Draft Mode** appears on the display, release both buttons.

Printing From a Memory Card or Camera

The Epson Stylus CX5800F all-in-one lets you print color photos directly from your digital camera's memory card; just insert it into a memory card slot on the Epson Stylus CX5800F and you're ready to print.

If your digital camera supports DPOF™ (Digital Print Order Format), you can pre-select the photos you want to print while the card is still in the camera. Then, when you insert the card in the Epson Stylus CX5800F, it knows which photos to print and how many copies of each.

If your camera is PictBridge®- or USB DIRECT-PRINT™-compatible, you can print your JPEG photos by connecting your digital camera directly to your Epson Stylus CX5800F. Your photos must be sized from 80 × 80 to 9200 × 9200 pixels.

See these sections:

- “Compatible Cards and Image Formats” on page 16
- “Inserting the Card” on page 17
- “Printing an Index Sheet to Select Photos” on page 18
- “Printing All Photos or DPOF Photos” on page 21
- “Printing From a Digital Camera” on page 22

For instructions on copying memory card files between your Epson Stylus CX5800F and a computer or other device, see the *User's Guide*.

Compatible Cards and Image Formats

You can use the following types of cards with your Epson Stylus CX5800F:

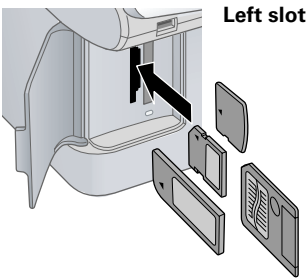
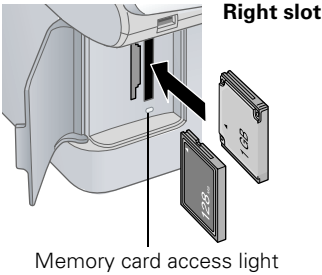

Slot	Type of card
Right slot	CompactFlash® Microdrive™
Left slot	SmartMedia™ Memory Stick™ MagicGate® Memory Stick MagicGate Memory Stick Duo* MultiMediaCard Memory Stick Duo™* Memory Stick PRO™ Memory Stick Pro Duo™* SD™ Card miniSD™ Card* xD-Picture Card™

* Adapter required

The Epson Stylus CX5800F supports image files that meet the following requirements:

Media format	DCF version 1.0 or 2.0 compliant*
File format	JPEG, DOS FAT (FAT 12 or 16, one partition) taken with a DCF version 1.0 or 2.0 compliant digital camera Supports Exif version 2.21
Image size	80 × 80 pixels to 9200 × 9200 pixels
Number of files	Up to 999

* DCF is the “Design rule for Camera File system” standard

Inserting the Card

1. Make sure the Epson Stylus CX5800F is turned on.

Note:

When you print directly from a memory card, it is best if the Epson Stylus CX5800F is not connected to your computer (or your computer is turned off).

2. Open the memory card door.

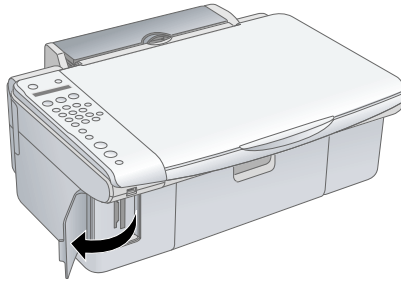

3. Make sure the memory card access light is off and that no cards are in any of the slots. Then insert your card into the correct slot. See page 16 for details.

Insert just one card at a time

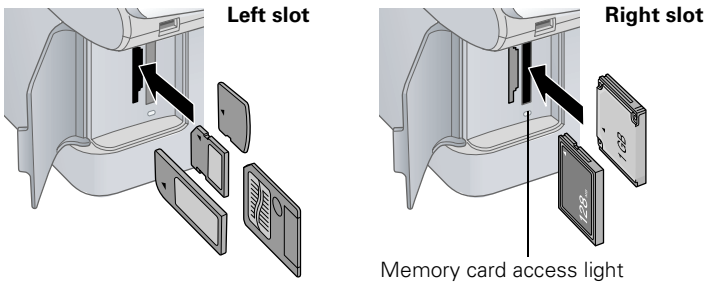

The memory card access light flashes and then stays on.

4. Close the memory card door. Now you can:
 - Print an index sheet so you can select which photos to print (page 18)
 - Print all the photos on the card (page 21)
 - Print photos pre-selected on your camera using DPOF (page 21)

When you want to remove the card, make sure the memory card access light is not flashing, then pull the card straight out of its slot.

Note:

You can print only in color when printing directly from a memory card; you cannot print in black and white.

Caution:

Do not remove the card or turn off the Epson Stylus CX5800F while the memory card access light is flashing; you may lose data on the card.

Printing an Index Sheet to Select Photos

You can print an index sheet (which is like a photographer's contact or proof sheet) to see small "thumbnail" images of all the photos on your card. Then you mark the photos on the index sheet that you want to print, scan the sheet, and let the Epson Stylus CX5800F automatically print the selected photos.

Printing the Index Sheet

1. Make sure your Epson Stylus CX5800F is not connected to your computer (or your computer is turned off).
2. Load several sheets of letter-size, plain paper. (Use only letter-size paper to print the index sheet.) Up to 30 images are printed on each page, so if there are more than 30 photos on the memory card, you'll need enough sheets for all the index pages to be printed.
3. Insert the memory card if it is not already in the slot. See page 17 for details.
4. If the light in the **Memory Card** button is not lit, press the **Memory Card** button. The Epson Stylus CX5800F counts the images on your card and you see this display, indicating it is ready to print the index sheet:

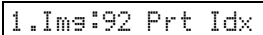

1.Ime:92 Prt Idx

5. Make sure **Plain Paper** and **Letter** are selected.

6. Press the OK button. The Epson Stylus CX5800F starts printing the index sheet(s). This may take a few minutes.

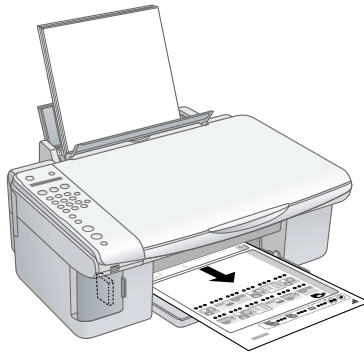

For multiple index sheets, the pages containing the most recent images are printed first. If you want to cancel printing more sheets, press the  Cancel/Back button.

Now follow the instructions below to select which photos to print.

Selecting Photos on the Index Sheet

1. Once you have printed the index sheet, use a dark pen or pencil to fill in one of the ovals beneath each photo you want to print to indicate how many copies you want (1, 2, or 3).

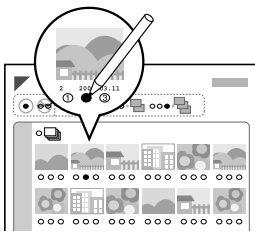

OK: 

No good:   

Make sure just one oval is filled in for each selected photo and mark the sheet carefully; once it has been scanned you will not be able to change your selections.

Note:

If you want one copy of all the photos on the index sheet, fill in the **ALL** oval at the top of the page.

2. Place the index sheet face-down on the glass, in the upper left corner, so that the top of the sheet is aligned against the left edge of the glass.

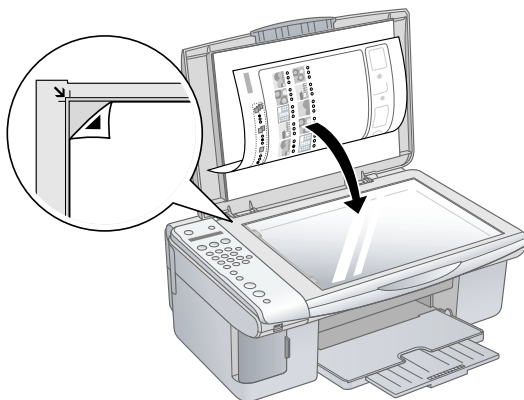

3. Close the document cover.
4. Load up to 100 sheets of plain paper or up to 20 sheets of photo paper at a time. (See page 7 for details.) You can load more paper later as necessary to print all your selected photos.
5. The display should now look like this, indicating that the Epson Stylus CX5800F is ready to scan the index sheet:

2.Ima:92 Scn Idx

If this setting is not displayed, press the **Memory Card** button until it is displayed.

6. Select **Plain Paper** or **Photo Paper** (whichever you loaded).

If you select **Plain Paper**, the photos print with a white border. If you select **Photo Paper**, the photos print borderless, to the edge of the paper.

7. Select **Letter, 4"×6"**, or **5"×7"** for the paper size.
8. Press the **OK** button to start printing.

Note:

If you need to stop printing, press the **Cancel/Back** button.

9. When you are done printing, remove the memory card by pulling it straight out of its slot.

Printing All Photos or DPOF Photos

Follow the steps below to print one copy of each photo on the card or to print only those photos that were pre-selected with your camera's DPOF feature.

1. Insert the memory card. See page 17 for details.
2. Load up to 100 sheets of plain paper or up to 20 sheets of photo paper at a time. (See page 7 for details.) You can load more paper later as necessary to print all your photos.
3. Press the **Memory Card** button repeatedly, until the display looks something like this.



3.Img:92 All/DPO

Note:

If the memory card does not contain DPOF information, one copy of all the photos on the card will be printed.

4. Select **Plain Paper** or **Photo Paper** (whichever you loaded).

If you select **Plain Paper**, the photos print with a white border. If you select **Photo Paper**, the photos print borderless, to the edge of the paper.

5. Select **Letter, 4" x 6"**, or **5" x 7"** for the paper size.
6. Press the **OK** button to start printing.

Note:

If you need to stop printing, press the **⊗ Cancel/Back** button.

7. When you are done printing, remove the memory card by pulling it straight out of its slot.

Printing From a Digital Camera

If your camera is PictBridge- or USB DIRECT-PRINT™-compatible, you can print your JPEG photos by connecting your digital camera directly to your Epson Stylus CX5800F. Your photos must be sized from 80 × 80 to 9200 × 9200 pixels.

1. Make sure your Epson Stylus CX5800F is not printing from a computer.
2. Remove any memory cards from the slots.
3. Load the type of paper you want to use. (See page 7 for details.) Load enough sheets for the number of photos you'll be printing.
4. Select **Plain Paper** or **Photo Paper** (whichever you loaded). If you select **Photo Paper**, the photos print borderless, to the edge of the paper.
5. Select **Letter, 4"×6"**, or **5"×7"** for the paper size.
6. Connect the USB cable that came with your camera to the USB connector on the front of your Epson Stylus CX5800F.

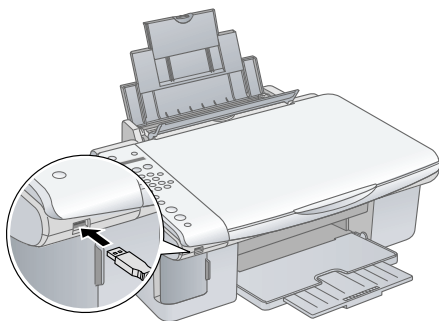

7. Turn on your camera and select the photos you want to print. Then adjust any necessary settings and print your photos as explained in your camera manual.
8. When you're finished, disconnect your camera and cable from the USB connector. (You cannot use the Epson Stylus CX5800F for any other purpose while your camera is connected.)

Note:

Epson cannot guarantee the compatibility of any camera.

Depending on the Epson Stylus CX5800F settings and your digital camera settings, some combinations of paper type, size, and layout may not be supported. In addition, some of your digital camera settings may not be reflected in the printed output.

Printing From Your Computer

This section describes the basic steps for printing a photo or document stored on your Windows or Macintosh computer.

Note:

For detailed instructions on printing, see the on-screen *User's Guide*.

Before you start, make sure you've installed your printer software and connected the Epson Stylus CX5800F all-in-one to your computer as described on the *Start Here* sheet. Also be sure to use the right paper and select the correct paper type setting in the printer driver. (See page 29 for details.)

Follow the instructions in these sections:

- "Printing in Windows" (below)
- "Printing With Macintosh OS X" on page 26
- "Using Special Papers" on page 29

Printing in Windows

1. Load paper. See page 7 for details.
2. Open the photo or document in your application program.
3. Open the File menu and select Print. You see a window like this one:

Select EPSON Stylus CX5800F Series

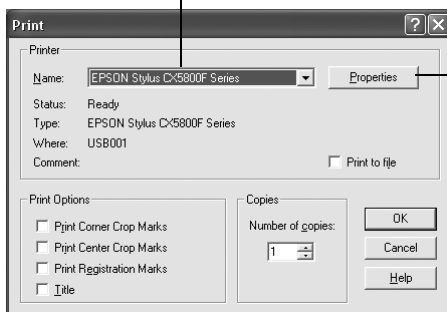

Click here to open your printer software

4. Make sure EPSON Stylus CX5800F Series is selected, then click the **Preferences** or **Properties** button.
(If you see a **Setup**, **Printer**, or **Options** button, click it. Then click **Preferences** or **Properties** on the next screen.)
5. On the Main tab, select the basic print settings:

Select the type of document you're printing
(choose **Photo** or **Best Photo** for photos)

The screenshot shows the 'Printing Preferences' dialog box for the EPSON Stylus CX5800F Series. The 'Main' tab is selected. The 'Quality Option' section has five radio buttons: 'Draft', 'Text', 'Text & Image' (selected), 'Photo', and 'Best Photo'. The 'Paper Options' section includes a 'Borderless' checkbox, a 'Type' dropdown menu set to 'Plain Paper / Bright White Paper', and a 'Size' dropdown menu set to 'Letter (8 1/2 x 11 in)'. The 'Print Options' section has three checkboxes: 'PhotoEnhance', 'Reverse Order', and 'Print Preview'. The 'Ink Levels' section shows four vertical bars representing ink levels. The 'Orientation' section has two radio buttons: 'Portrait' (selected) and 'Landscape'. At the bottom, there are buttons for 'Reset Defaults', 'Online Support', 'Show Settings', 'Advanced', 'OK', 'Cancel', and 'Help'. Annotations with lines pointing to specific elements include: 'Select your paper Type' pointing to the Quality Option section; 'Select your paper Size' pointing to the Paper Options section; 'Click here for borderless photos, after choosing paper Type' pointing to the Borderless checkbox; 'Select your document Orientation' pointing to the Orientation section; and 'Click here for more options' pointing to the Advanced button.

Select your paper Type

Select your paper Size

Click here for borderless photos, after choosing paper Type

Select your document Orientation

Click here for more options

Make sure you choose the correct paper **Type** setting for the paper you are using. See page 29 for details.

Note:

For more information about print settings, click the **?** or **Help** button.

- For more printing options, click the **Advanced** button. Then select the following settings as necessary:

Select a color management method
(To choose **No Color Adjustment**, click **ICM** first)

Select **Paper & Quality Options** as necessary

Select **Print Options** as necessary

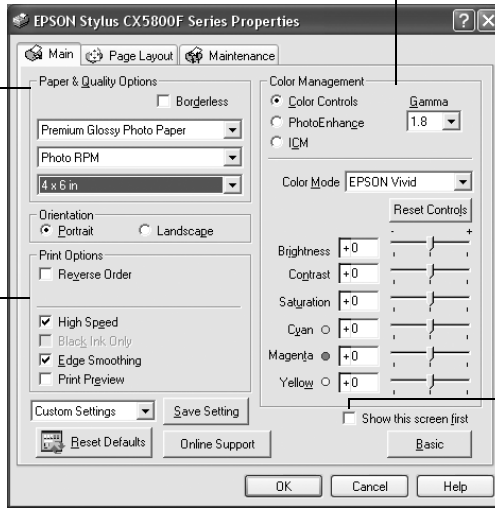

Click here if you want to see this Advanced screen each time you access your print settings

Note:

For more information about advanced settings, or instructions on saving them as a group so you can reuse them later, click **?** or **Help**.

- If you want to change the layout settings, click the **Page Layout** tab and select settings as necessary.
- Click **OK** to save your settings, then click **OK** or **Print** to start printing. This window appears and shows the progress of your print job.

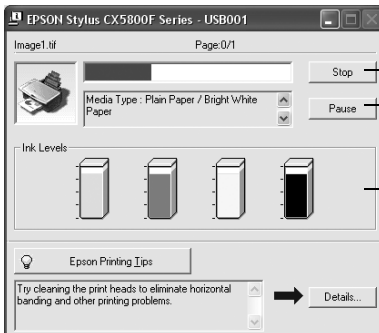

Cancel printing

Pause or resume printing

Check remaining ink levels

Printing With Macintosh OS X

If you're using an OS X-compatible application, follow the steps below to print.

1. Load paper. See page 7 for details.
2. Open the photo or document in your application program.
3. Open the File menu and select **Page Setup**. Make the following settings:

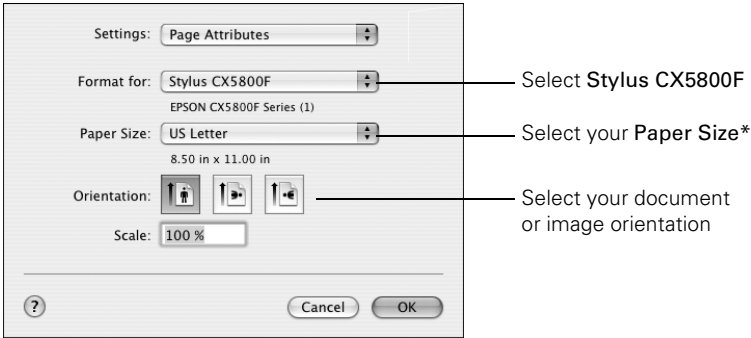

* For borderless printing, choose the (**Sheet Feeder - Borderless**) option in the Paper Size list for your paper size (**US Letter, 8 x 10, 5 x 7, or 4 x 6**).

4. Click **OK** to close the Page Setup window.
5. Open the File menu and select **Print**. You see a window like this one:

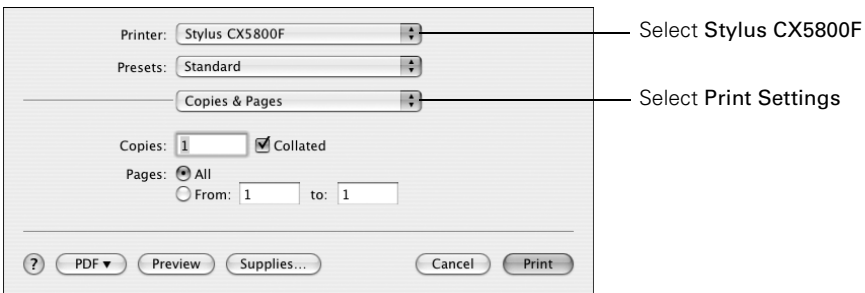

6. Choose **Print Settings** from the pop-up menu and select the following settings as necessary:

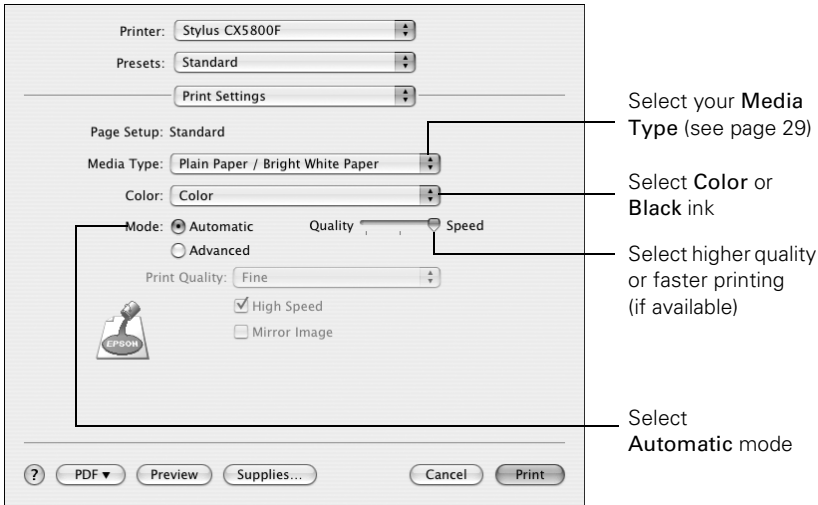

Note:

For more information about printer settings, click the ? button.

7. Depending on your settings, you can choose these other options from the pop-up menu:
- **Copies & Pages:** Select the number of copies you want, or a page range.
 - **Layout:** Select page layout options.
 - **Output Options (OS X 10.2.x or 10.3.x only):** Save your print job as a PDF file. In OS X 10.4.x, click the **PDF** button instead.
 - **Scheduler:** Schedule your print job to print at a later time.
 - **Paper Handling:** Select page printing options, such as **Reverse print order** or **Page Order**.
 - **ColorSync or Color Management:** Select ColorSync® or adjust the color controls, change the gamma setting, or turn off color adjustments in the printer software.
 - **Cover Page (OS X 10.4.x only):** Print a cover page before or after your document.
 - **Expansion:** Reduce or enlarge the image size for borderless printing.
 - **Summary:** View a list of all your selections.

8. Click the **Advanced** button to change additional settings.

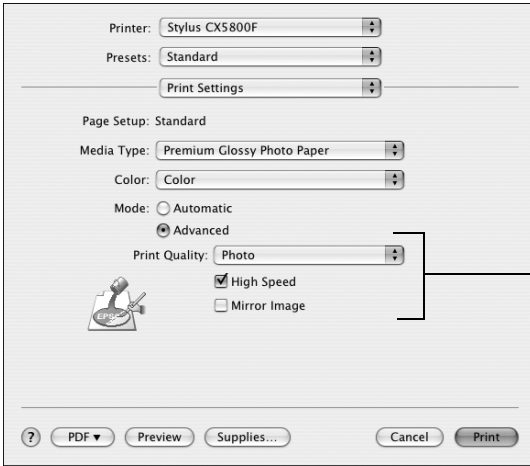



Select **Print Quality** and other options as necessary

Note:

For more information on advanced settings, or instructions on saving them as a group so you can reuse them later, click ?.

9. Click **Print**.

10. To monitor the progress of your print job, click the  printer icon when it appears in the dock on the bottom of your desktop.

If you're using OS X 10.2.x, click the  Print Center icon instead, then double-click **Stylus CX5800F** in the Printer List window.

You see a screen like this:

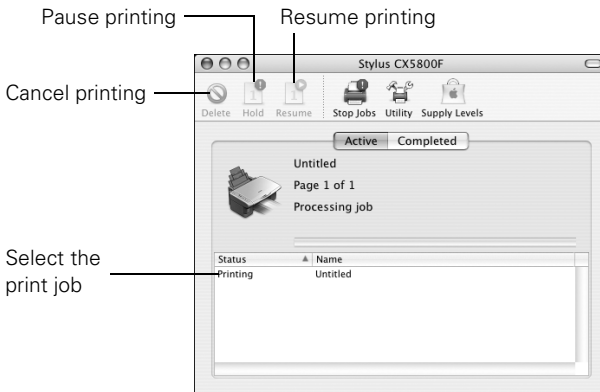

11. When you're finished, close the printer window or Print Center.

Using Special Papers

You can purchase genuine Epson ink and paper from an authorized Epson reseller. To find the nearest reseller, please call 800-GO-EPSON (800-463-7766). To purchase online, visit www.epsonstore.com (U.S. sales only). In Canada, please call (800) 463-7766 for reseller referral.

Paper name	Size	Part number
Epson Premium Bright White Paper	Letter (8.5 × 11 inches)	S041586
Epson Premium Glossy Photo Paper	Borderless 4 × 6 inches	S041808/S041727
	Borderless 5 × 7 inches	S041464
	Borderless 8 × 10 inches	S041465
	Letter (8.5 × 11 inches)	S041286/S041667
Epson Ultra Premium Glossy Photo Paper	Borderless 4 × 6 inches	S041934
	Letter (8.5 × 11 inches)	S041935
Epson Premium Semigloss Photo Paper	Letter (8.5 × 11 inches)	S041331
Epson Glossy Photo Paper	Borderless 4 × 6 inches	S041809
	Letter (8.5 × 11 inches)	S041141/S041649/ S041272/S041271
Epson Matte Paper Heavyweight	Borderless 8 × 10 inches	S041467
	Letter (8.5 × 11 inches)	S041257
Epson Double-Sided Matte Paper	Letter (8.5 × 11 inches)	S041568
Epson Photo Quality Ink Jet Paper	Letter (8.5 × 11 inches)	S041062
	Legal (8.5 × 14 inches)	S041067
	A4 (8.3 × 11.7 inches)	S041061

Select the correct **Type** (see page 24) or **Media Type** (see page 27) setting in your printer software:

For this paper	Select this setting
Plain paper or Epson Premium Bright White Paper	Plain Paper/Bright White Paper
Epson Matte Paper Heavyweight Epson Double-Sided Matte Paper Epson Photo Quality Ink Jet Paper	Matte Paper - Heavyweight
Epson Ultra Premium Glossy Photo Paper	Ultra Premium Glossy Photo Paper
Epson Premium Glossy Photo Paper	Premium Glossy Photo Paper
Epson Premium Semigloss Photo Paper	Premium Semigloss Photo Paper
Epson Glossy Photo Paper	Glossy Photo Paper
Envelopes	Envelope

Faxing a Photo or Document

Your Epson Stylus CX5800F all-in-one lets you send faxes by entering fax numbers or selecting entries from a speed dial list. You can customize the fax header information, and select various report printing and send/receive settings. You can also set up your Epson Stylus CX5800F to automatically receive faxes or select to receive them only when you've confirmed that you're receiving a fax.

See these sections:

- “Connecting a Phone or Answering Machine” below
- “Setting Up Your Fax Features” on page 32
- “Sending a Fax” on page 39
- “Receiving a Fax” on page 41

For more information on faxing and selecting fax settings, see the *User's Guide*.

Connecting a Phone or Answering Machine

If you're connecting the Epson Stylus CX5800F to a phone line, and connecting a telephone or answering machine to the same phone line so you can use it to make voice calls, follow these steps:

1. Connect the phone cable leading from the wall jack to the **LINE** port.
2. Connect one end of another phone cable to the telephone or answering machine.
3. Connect the other end of the cable to the **EXT** port on the back of the Epson Stylus CX5800F.

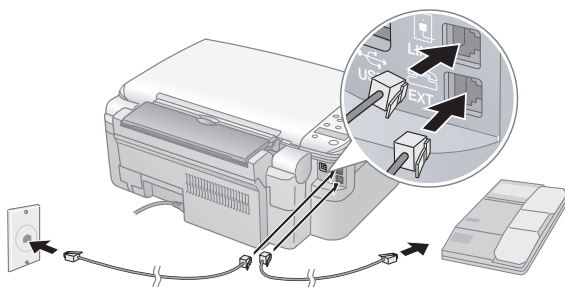

You also need to set up your Epson Stylus CX5800F to receive faxes manually. See page 41 for details.

Setting Up Your Fax Features

Before sending or receiving faxes, you may want to create a fax header, select your fax preferences, and set up a speed dial list of frequently used fax numbers.

Creating Header Information

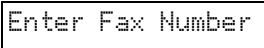
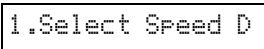
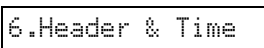
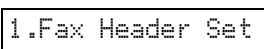
1. Press the **Fax** button once to enter Fax mode. The **Fax** button lights up and you see this display: 
2. Press the **Setup** button. You see this display: 
3. Press the **▲** or **▼** button, or press the **6** key on the numeric keypad, to display this option: 
4. Press the **OK** button. You see this display: 
5. Press the **OK** button again. The display goes blank except for the cursor (_).
6. Press the keys on the numeric keypad to enter up to 28 digits of header information. Use the number keys to enter the letters A to Z (in uppercase or lowercase), the numbers 0 to 9, and various symbols.

Press a key repeatedly to display first the numbers and symbols (if available), then the uppercase and lowercase letters, as indicated on the key. Then wait a moment or press the **▶** button to move to the next character space. When you're finished, press the **▶** button to move to a blank space.

Note:

If you need to change a character to the left, press the **◀** key to delete the character and re-enter it. Press the **▶** key if you need to move the cursor to the right.

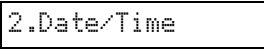
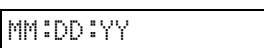
7. Press the **OK** button. You return to the **1.Fax Header Setup** display.
8. Press the **▲** or **▼** key, or press the **2** key on the numeric keypad, to display this option: 
9. Press the **OK** button. You see this display (to indicate the two-digit month, day, and year): 

10. Press the keys on the numeric keypad to enter the date. You can enter the numbers 0 to 9.

11. Press the **OK** button. You see this display (to indicate the hour and minute):



12. Press the keys on the numeric keypad to enter the time in a 12-hour format. You can enter the numbers 0 to 9.

13. Press the **OK** button. You see this display:



14. Press the **1** key or the **2** key on the numeric keypad to select **AM** (1) or **PM** (2).

15. Press the **OK** button. You return to the **2.Date/Time** display.

16. If you want to print your fax number in the fax header, press the **▲** or **▼** button, or press the **3** key on the numeric keypad, to display this option:



17. Press the **OK** button. The display goes blank except for the cursor (**_**).

18. Press the keys on the numeric keypad to enter your fax number. You can enter the numbers 0 to 9, and the characters ***** and **#**; up to 20 digits total.

19. Press the **OK** button.

20. Press the **⊗ Cancel/Back** button until you return to the first screen.

Selecting the Paper Size

Before you receive a fax, be sure to load plain paper and set the **Paper Size** setting to the size of paper you've loaded. Also make sure the **Automatic Reduction** setting is set to receive faxes in the desired size. See the next section for details.



Selecting Send/Receive Settings

Your Epson Stylus CX5800F is set up to send and receive faxes using the default settings below. For more information about fax settings, see the *User's Guide*.

Setting and Options	Description
Paper Size Letter (8.5 × 11; default) Legal (8.5 × 14) A4 (8.3 × 11.7)	Indicates the size of the paper loaded in the Epson Stylus CX5800F for printing received faxes.
Automatic Reduction On (default) Off	Indicates whether large received faxes are reduced in size to fit on the selected Paper Size or printed at their original size on multiple sheets.
Last Transmission Report Off On Error (default) On Send	Indicates whether or when the Epson Stylus CX5800F prints a report for outgoing faxes. Select Off to turn off report printing, On Error to print reports only when an error occurs, or On Send to print reports for every fax you send.
Fax Mode B&W/Color B&W Only (default)	Indicates whether you can send faxes in black and white or color (by pressing the appropriate Start button) or in black and white only (by pressing either Start button). If you send a color fax to a recipient's fax machine that prints only in black and white, and the Fax Mode is set to B&W/Color , you see an error message and must resend the fax.
Dial Mode Tone (default) Pulse	Indicates the type of phone system to which you've connected the Epson Stylus CX5800F.
DRD All (default) Single Double Triple Double & Triple	Indicates the type of answer ring pattern you want to use to receive faxes. You must have set up your phone system to use different ring patterns to select an option other than All .
ECM: On/Off On (default) Off	Indicates whether you use Error Correction Mode to automatically request retransmission of fax data that is received with detected errors.

Setting and Options	Description
V.34: On/Off On (default) Off	Indicates the speed at which you transmit faxes. On is 33.6 Kbps and Off 14.4 Kbps.
Rings to Answer 4 (default) 1, 2, 3, 5, 6, 7, 8, or 9	Indicates the number of rings that must occur before the Epson Stylus CX5800F automatically receives a fax.

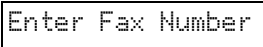
To change the fax settings listed above, follow these steps:

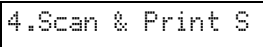
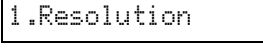
1. Press the **Fax** button once to enter Fax mode. The **Fax** button lights up and you see this display: 
2. Press the **Setup** button. You see this display: 
3. If you need to change the **Paper Size, Automatic Reduction, or Last Transmission Report** settings, press the **▲** or **▼** button, or press the **4** key on the numeric keypad, to display this option: 
4. Press the **OK** button. You see this display: 
5. Press the **▲** or **▼** button, or press the **3, 4, 5, or 6** key on the numeric keypad, to display one of these options:
 - 3.Paper Size
 - 4.Automatic Reduction
 - 5.Last Transmission Report
 - 6.Fax Mode

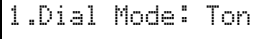
Then press the **OK** button.
6. Press the **▲** or **▼** button until the setting option you want is displayed, then press the **OK** button to select it.
7. Repeat steps 5 and 6 to change any other settings. When you're finished, press the **⊗ Cancel/Back** button to return to the **4.Scan & Print Setup** menu.
8. If you need to change the **Dial Mode, DRD, ECM, V.34, or Rings to Answer** settings, press the **▲** or **▼** button, or press the **5** key on the numeric keypad, to display this option: 
9. Press the **OK** button. You see this display: 

10. To change the Dial Mode setting, press OK and go to step 11.

To change another Communication setting, press the ▲ or ▼ button, or press the 2, 3, 4, or 5 key on the numeric keypad, to display one of these options:

- 2.DRD
- 3.ECM: On/Off
- 4.V.34: On/Off
- 5.Rings to Answer

Then press the OK button.

11. Press the ▲ or ▼ button until the setting option you want is displayed, then press the OK button to select it.

12. Repeat steps 10 and 11 to change any other settings. When you're finished, press the Ⓞ Cancel/Back button to return to the first screen.

Setting Up Your Speed Dial List

You can create a speed dial list of up to 60 fax numbers so you can quickly select them for faxing. You can also add names to identify the recipients and print the speed dial list.

1. Press the Fax button once to enter Fax mode. The Fax button lights up and you see this display:

Enter Fax Number

2. Press the Setup button. You see this display:

1.Select Speed D

3. Press the ▲ or ▼ button, or press the 3 key on the numeric keypad, to display this option:

3.Speed Dial Set

4. Press the OK button. You see this display:

1.Add Entry

5. Press the OK button again. You see this display:

[01]

6. Press the OK button again. The screen displays Telephone Number briefly, then goes blank except for a cursor (|).

7. Press the keys on the numeric keypad to enter the fax number of the first speed dial entry. You can enter the numbers 0 to 9, and the characters * and #; up to 64 digits total.

1234567890

Note:

If you need to change a character to the left, press the ◀ button to delete the character and re-enter it. Press the ▶ button if you need to move the cursor to the right.

8. Press the **OK** button again. The screen displays **Name** briefly, then goes blank except for a cursor (▬).
9. Press the keys on the numeric keypad to enter a name for the speed dial entry (up to 30 characters). Use the number keys to enter the letters A to Z (in uppercase or lowercase), the numbers 0 to 9, and various symbols.

Main Office

Press a key repeatedly to display first the numbers and symbols (if available), then the uppercase and lowercase letters, as indicated on the key. Then wait a moment or press the ▶ button to move to the next character space. When you're finished, press the ▶ button to move to a blank space.

Note:

If you need to change a character to the left, press the ◀ button to delete the character and re-enter it. Press the ▶ button if you need to move the cursor to the right.

10. Press the **OK** button. You see this display, indicating the next available speed dial entry number:
11. If you want to add another speed dial entry, repeat steps 6 through 10.
When you're finished, press the Ⓞ **Cancel/Back** button to return to the **3.Speed Dial Setup** menu.

[02]

Editing or Deleting a Speed Dial Entry

1. To edit a speed dial entry, press the **OK** button. Then press the ▲ or ▼ button, or the 2 key on the numeric keypad, to display this option:
2. Press the **OK** button. You see the first speed dial entry number and name displayed.
3. Press the **OK** button to edit this entry, or press the ▲ or ▼ button to select a different entry and press the **OK** button.

2.Edit Entry

4. The phone number for the selected entry is displayed. Press the ► button to move to the digits you want to edit. Press the 0 to 9 number keys to enter new numbers or press the ◀ button to delete digits to the left. When you're finished, press the OK button.
5. The name for the selected entry is displayed. Edit the name the same way as in step 4. When you're finished, press the OK button to return to the 2.Edit Entry display.
6. Press the Ⓞ Cancel/Back button to return to the 3.Speed Dial Setup menu.
7. To delete a speed dial entry, press the OK button. Then press the ▲ or ▼ button, or the 3 key on the numeric keypad, to display this option:

3.Delete Entry
8. Press the OK button. You see the first speed dial entry number (such as [1]) and name displayed.
9. Press the OK button to delete this entry, or press the ▲ or ▼ button to select a different entry and press the OK button to delete it.

Printing Your Speed Dial List

1. Press the Ⓞ Cancel/Back button to return to the first fax screen.
2. Press the Setup button. You see this display:

1.Select Speed D
3. Press the ▲ or ▼ button, or press the 2 key on the numeric keypad, to display this option:

2.Print Report
4. Press the OK button. You see this display:

1.Speed Dial Lis
5. Press OK to print the speed dial list.

Sending a Fax

Before you fax, place your original document or photo on the document table glass as described on page 9. Then send your fax by manually entering a fax number, redialing the previous fax number, or selecting an entry from your speed dial list.

Manually Entering or Redialing a Fax Number

1. Press the **Fax** button once to enter Fax mode. The **Fax** button lights up and you see this display:

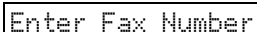

Enter Fax Number

2. Press the keys on the numeric keypad to enter the fax number. You can enter the numbers 0 to 9 and the characters * and #; up to 64 digits total.



1234567890

Note:

If you need to change a character to the left, press the ◀ button to delete the character and re-enter it. Press the ▶ button if you need to move the cursor to the right.

If you want to redial the last fax number you used, press the **Redial/Pause** button instead of entering a fax number. The last fax number appears on the screen.

3. To send a black-and-white fax, press the ◊ **Start B&W** button.

To send a color fax, press the ◊ **Start Color** button. (If the Fax Mode setting is set to **B&W Only**, the fax is sent in black and white. See page 34 for details.)

You see this display during faxing:



Scanning 001 98%

Note:

If you need to cancel faxing at any time, press the ⊗ **Cancel/Back** button.

4. After your original is scanned, you see this screen:



Send another Fax

If you do not need to fax another page, press the **2** key (for No). The Epson Stylus CX5800F dials the fax number and faxes your document.

Note:

If the fax number is busy or there is some other connection problem, you see an error message and the Epson Stylus CX5800F returns to the first fax mode screen. The Epson Stylus CX5800F redials the number after one minute. Wait for the redial, or check your connection and settings and try faxing again.

If you need to fax another page, press the **1** key (for Yes). Open the document cover, remove your first original, place your next original, and close the document cover. Then press the **OK** button to fax the next page. Repeat this step to fax all the necessary pages.

Note:

If you're sending a color fax, or a large document that fills up the memory area, the Epson Stylus CX5800F scans and faxes one page at a time. It then asks if you want to send another page. The fax connection stays open until you are finished.

Speed Dialing a Fax Number

1. Press the **Fax** button once to enter Fax mode. The **Fax** button lights up and you see this display:

A rectangular display box with a black border containing the text "Enter Fax Number" in a monospaced font.

2. Press the **Setup** button. You see this display:

A rectangular display box with a black border containing the text "1.Select Speed D" in a monospaced font.

3. Press the **OK** button. You see the first speed dial entry name or number from your list displayed.

4. To fax to the first speed dial entry, press the **OK** button. Then go to step 5.

To select a different speed dial entry, press the **▲** or **▼** button to display the entry, or press the number key that corresponds to the speed dial entry number. Press the **OK** button, then go to step 5.

5. To send a black-and-white fax, press the **◇ Start B&W** button.

To send a color fax, press the **◇ Start Color** button. (If the Fax Mode setting is set to **B&W Only**, the fax is sent in black and white. See page 34 for details.)

You see this display during faxing:

A rectangular display box with a black border containing the text "Scanning 001 98%" in a monospaced font.

Note:

If you need to cancel faxing at any time, press the **⊗ Cancel/Back** button.

6. After your original is scanned, you see this screen:

A rectangular display box with a black border containing the text "Send another pag" in a monospaced font.

If you do not need to fax another page, press the **2** key (for No). The Epson Stylus CX5800F dials the fax number and faxes your document.

Note:

If the fax number is busy or there is some other connection problem, you see an error message and the Epson Stylus CX5800F returns to the first fax mode screen. The Epson Stylus CX5800F redials the number after one minute. Wait for the redial, or check your connection and settings and try faxing again.

If you need to fax another page, press the **1** key (for Yes). Open the document cover, remove your first original, place your next original, and close the document cover. Then press the **OK** button to fax the next page. Repeat this step to fax all the necessary pages.

Note:

If you're sending a color fax, or a large document that fills up the memory area, the Epson Stylus CX5800F scans and faxes one page at a time. It then asks if you want to send another page. The fax connection stays open until you are finished.

Receiving a Fax

The Epson Stylus CX5800F automatically receives and prints faxes in Auto Answer mode. However, you may want to receive faxes manually if you connected the Epson Stylus CX5800F and a phone or answering machine to a phone line that also receives voice calls. Then you can check for a fax tone from the sending fax machine and press a button on the Epson Stylus CX5800F to receive the fax, or allow your answering machine to determine if the call is an incoming fax.

Note:

Make sure you selected the **Paper Size** setting that matches the size of paper you've loaded. If the incoming fax pages are larger than the paper size you loaded, the fax size is reduced to fit or printed on multiple pages, depending on the **Automatic Reduction** setting you select. See page 34 for details.

Selecting the Answer Mode

The Epson Stylus CX5800F tells you whether Auto Answer is turned on or not on the first screen:

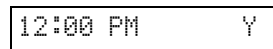

Y: Auto Answer is turned on

To change the answer mode, press the **Answer Mode** button. The **Y** or **N** changes on the first screen. Press **Answer Mode** again to change it back.

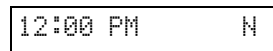

N: Auto Answer is turned off

Note:

You can select the number of rings that must occur before the Epson Stylus CX5800F receives a fax using the **Rings to Answer** setting. See page 34 for details.

Receiving a Fax

When the Epson Stylus CX5800F receives a fax with Auto Answer mode turned on, the message **Receiving** appears on the display.

When the Epson Stylus CX5800F receives a fax in manual answer mode, the connected phone begins ringing. Once you answer the phone to confirm that the call is a fax, press the **◇ Start B&W** or **◇ Start Color** button to receive the fax. The message **Receiving** appears on the display.

After the Epson Stylus CX5800F receives all the pages, it begins printing the fax. When it's finished, you see the message **Complete**.

Note:

If you run out of paper during printing, you see the error message **Paper out**. Load more paper and press the **OK** button so printing can continue. If you see any other error messages, see page 55.

Scanning a Photo or Document

You can use your Epson Stylus CX5800F all-in-one to scan a photo or document and save it on your computer or other device.

You can even automatically restore faded color photographs as you scan. See page 45 for details.

The EPSON Scan software provides three scanning modes for progressive levels of control over your scanned image:

- **Full Auto Mode** scans quickly and easily using automatic settings.
- **Home Mode** previews your image and provides automatic image adjustments, cropping tools, and preset options for various types of scans.
- **Professional Mode** previews your image and lets you manually configure your scan settings with a full array of tools.

Basic Scanning

You can scan from any TWAIN-compliant application—such as ArcSoft PhotoImpression™—using EPSON Scan. Or you can start EPSON Scan directly from your computer and save your image to a file.

1. Open the document cover and place your original face-down on the glass, in the upper left corner. Move your original about 0.04 inch (1 mm) away from the top and left edges so all of it will be scanned.

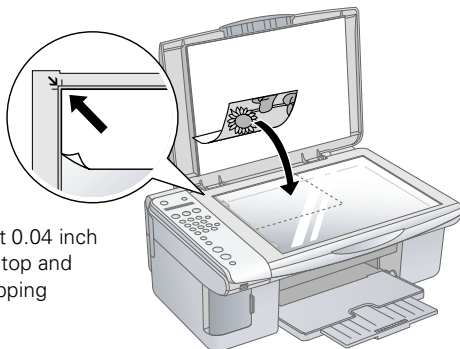

Move the original about 0.04 inch (1 mm) away from the top and left edges to avoid cropping

Note:

If you need to scan a thick document, you can remove the document cover. See page 10 for details.

2. Close the document cover gently so you don't move the original.
3. Do one of the following to start EPSON Scan:
 - **Windows:** Double-click the EPSON Scan icon on your desktop.
 - **Macintosh:** Double-click EPSON Scan in the Applications folder.
 - If you are scanning from an application, start your application. Then open the File menu, choose **Import** or **Acquire**, and select EPSON Stylus CX5700F/CX5800F.

You see the EPSON Scan standby window:

4. If the Mode setting in the upper right corner is set to **Full Auto Mode**, click the **Scan** button.

Note:

If you want to automatically restore a color photo as you scan, click the **Customize** button. See page 45 for details.

If you are in Home or Professional Mode, you see a different EPSON Scan settings window. (You can change the mode using the Mode selector in the upper right corner. For details, see the on-screen *User's Guide*.)

5. You see the File Save Settings window:

Choose the location where you want to save your scanned file and type a name for it in the Prefix box. Select a file format in the Image Format box.

6. Click **OK**. The image is scanned and you see its icon in an open folder.

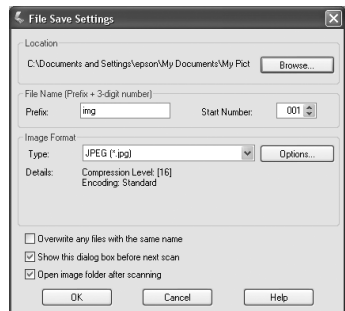
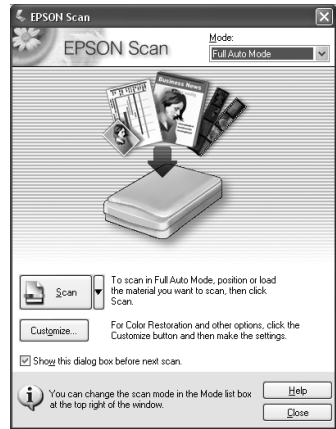

Restoring Color in Faded Photos

You can automatically transform an old, faded, or badly exposed color photo into one with true-to-life color and sharpness as you scan. Look for the **Color Restoration** option in EPSON Scan's Full Auto, Home, and Professional Mode screens:

Full Auto Mode

Click the **Customize** button, click to select the **Color Restoration** checkbox, click **OK**, and click **Scan**.

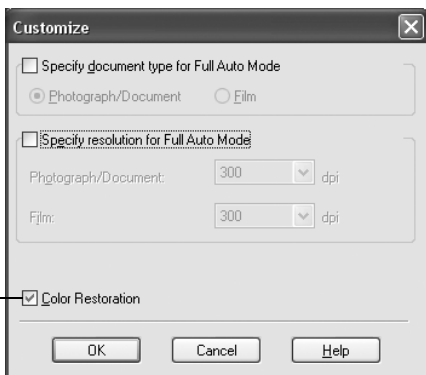

Home Mode

Preview your image, click to select the **Color Restoration** checkbox, and click **Scan**.

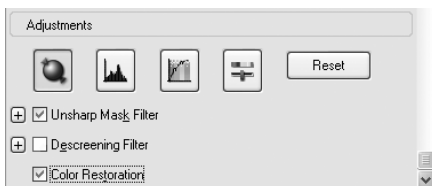

Professional Mode

Preview your image, scroll down to the **Adjustments** area, click to select the **Color Restoration** checkbox, and click **Scan**.

Note:

For details on using Home or Professional Mode, or for more information about Full Auto Mode settings, see the on-screen *User's Guide*. You can also click **Help** on the EPSON Scan screen for information about all the available settings.



Maintaining Your Epson Stylus CX5800F

If you notice a decline in print quality, follow the instructions in this chapter for:

- “Checking the Print Head Nozzles” (below)
- “Cleaning the Print Head” on page 48
- “Checking the Ink Levels” on page 49
- “Replacing Ink Cartridges” on page 50

Checking the Print Head Nozzles

If your printouts are faint or have gaps in them, some of the nozzles in the print head may be clogged. Follow the steps below to check the print head nozzles using the control panel.

1. Load letter-size paper in the sheet feeder.
2. Press the  **On** button to turn on the Epson Stylus CX5800F, or press the  **Cancel/Back** button until you see a screen like this:

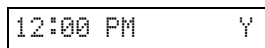

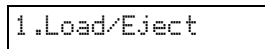

12:00 PM Y

3. Press the **Setup** button. You see this display:



1.Load/Eject

4. Press the  or  button, or press the **3** key on the numeric keypad, to display this option:

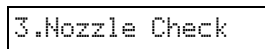

3.Nozzle Check

5. Press the **OK** button. The Epson Stylus CX5800F prints a test pattern like this:

Print head does not need to be cleaned:

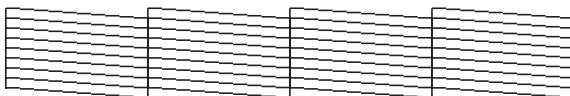

Print head needs to be cleaned:

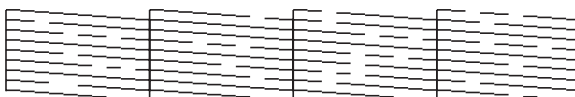

6. Press the  **Cancel/Back** button to return to the first screen.

If the pattern does not look good, try cleaning the print head as described on the next page.

Note:

You can also check the print head nozzles using software when the Epson Stylus CX5800F is connected to your computer. See the *User's Guide* for instructions.



Cleaning the Print Head

If your printouts are unexpectedly light or faint, or you notice light or dark bands across your printout, you may need to clean the print head. This unclogs the nozzles so they can deliver ink properly. Run a nozzle check as described on page 47 to see if the print head needs cleaning.

Note:

Print head cleaning uses ink, so clean it only if quality declines and the nozzle check indicates that the print head needs to be cleaned.

If you see an ink error message on the display, you cannot clean the print head. In this case, press the **OK** button and replace the appropriate ink cartridge first. See page 50 for details.

1. Press the  **On** button to turn on the Epson Stylus CX5800F, or press the  **Cancel/Back** button until you see a screen like this:

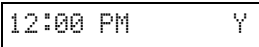

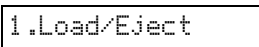

12:00 PM Y

2. Press the **Setup** button. You see this display:



1.Load/Eject

3. Press the  or  button, or press the 4 key on the numeric keypad, to display this option:

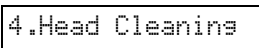

4.Head Cleaning

4. Press the **OK** button. The Epson Stylus CX5800F runs a head cleaning cycle and the message **Cleaning . . .** appears on the display.

Caution:

Never turn off the Epson Stylus CX5800F while head cleaning is in progress. You may damage it.

5. When the display returns to **4.Head Cleaning**, run a nozzle check to verify that the print head is clean. See page 47 for details.
6. If there are still gaps or lines, or the test patterns are faint, run another cleaning cycle and check the nozzles again.

Note:



If you don't see any improvement after cleaning the print head four or five times, turn off the Epson Stylus CX5800F and wait overnight. This lets any dried ink soften. Then try cleaning the print head again. If quality still does not improve, one of the ink cartridges may be old or damaged and needs to be replaced. See page 50 for details.

Caution:

If you do not use your Epson Stylus CX5800F often, it is a good idea to print a few pages at least once a month to maintain good print quality.

Checking the Ink Levels

You can check the approximate level of ink in your cartridges using the control panel.

1. Press the  **On** button to turn on the Epson Stylus CX5800F, or press the  **Cancel/Back** button until you see a screen like this:





12:00 PM Y

2. Press the **Setup** button. You see this display:



1.Load/Eject

3. Press the  or  button, or press the **2** key on the numeric keypad, to display this option:

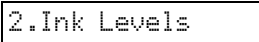

2.Ink Levels

4. Press the **OK** button. You see a display like this:

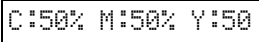

C:50% M:50% Y:50

If one or more cartridges are low on ink, you see a display like this:

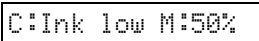

C:Ink low M:50%

5. Press the **OK** or  **Cancel/Back** button to return to the first screen.

If you need to replace an ink cartridge, see page 50.

Note:

You can also check the ink levels using software when the Epson Stylus CX5800F is connected to your computer. See the *User's Guide* for instructions.

Replacing Ink Cartridges

If you see a message like this on the display, one or more cartridges are low on ink:

```
Cyan ink low->Pr
```

When you see a message like this on the display, you need to replace one or more cartridges:

```
Cyan ink out->Pr
```

You cannot print when a cartridge is empty.

Note:

You'll also see a low ink or ink out message on your computer screen when you print from your computer.

You can purchase genuine Epson ink and paper from an authorized Epson reseller. To find the nearest reseller, please call 800-GO-EPSON (800-463-7766). To purchase online, visit www.epsonstore.com (U.S. sales only). In Canada, please call 800-463-7766 for reseller referral.



Use these part numbers when you order or purchase new ink cartridges:

Color	Part number
Black	T060120
Cyan	T060220
Magenta	T060320
Yellow	T060420

Caution:

Leave the empty cartridge installed until you have obtained a replacement, or the ink remaining in the print head nozzles may dry out.



We recommend that you use genuine Epson cartridges. The use of other products may affect your print quality and could result in printer damage. Yields vary considerably based on images printed, print settings, paper type, frequency of use, and temperature. The printer ships with full cartridges and part of the ink from the first cartridges is used for priming the printer.

1. Press the  **On** button to turn on the Epson Stylus CX5800F, or press the  **Cancel/Back** button until you see a screen like this:

12:00 PM	Y
----------	---

2. Press the **Setup** button. You see this display:

1.Load/Eject

3. Press the  or  button, or press the **5** key on the numeric keypad, to display this option:

5.Replace Cartri

4. Press the **OK** button.

5. Make sure that the document cover is closed, then open the scanner.

Caution:

Do not open the scanner when the document cover is open.

Do not move the print head by hand; this may damage the Epson Stylus CX5800F. Always select **5.Replace Cartridge** from the display to move it.

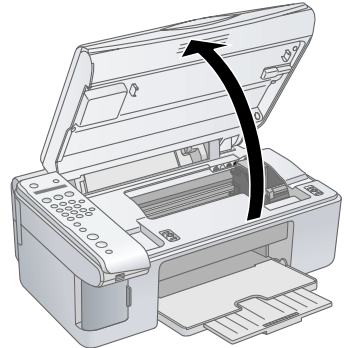

6. Open the cartridge cover, then squeeze the tab at the back of the cartridge and lift it straight out. Dispose of it carefully. Do not take the used cartridge apart or try to refill it.

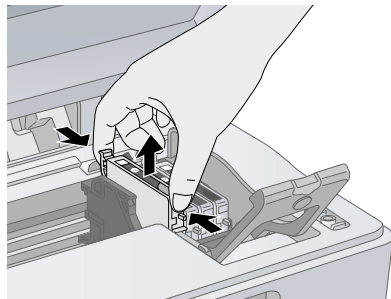
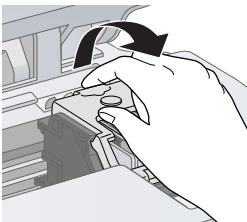

Warning:

If ink gets on your hands, wash them thoroughly with soap and water. If ink gets into your eyes, flush them immediately with water.

7. Before you open the new ink cartridge package, shake it four or five times. Then remove it from the package.

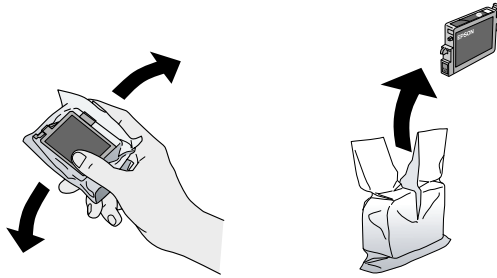

Caution:

Do not remove or tear the label on the cartridge; otherwise, ink will leak.

Do not touch the green chip on the front of the cartridge. This can damage the ink cartridge.



8. Place the new ink cartridge into the cartridge holder and push it down until it clicks into place.

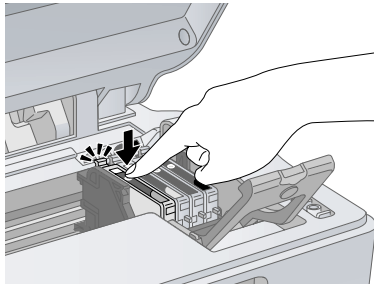

9. Replace any other cartridges that need to be replaced.
10. Close the ink cartridge cover and press it until it clicks into place.

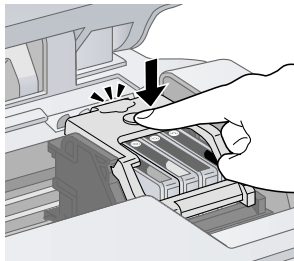

11. Close the scanner.

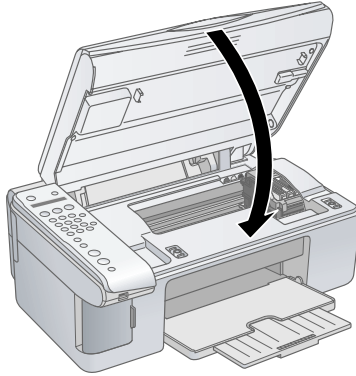

12. Press the OK button. The Epson Stylus CX5800F begins charging ink and **Charging** appears on the display.

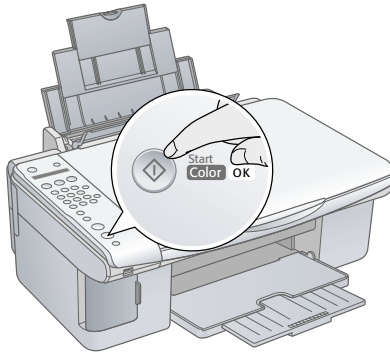

Charging takes about one minute. When it's finished, **5.Replace Cartridge** appears on the display.

Caution:

Never turn off the Epson Stylus CX5800F while **Charging** appears on the display or you'll waste ink.

Note:

If you see an ink cartridge error message on the display, the ink cartridge may not be installed correctly. Press the **OK** button and reinstall the ink cartridge until it clicks into place.

13. Press the **Cancel/Back** button until you return to the first screen.

Solving Problems

If you have a problem with your Epson Stylus CX5800F all-in-one, check the display on the control panel to diagnose the cause.

You can also check “Problems and Solutions” on page 57 for basic troubleshooting suggestions, or double-click the *User’s Guide* icon on your computer desktop for more detailed help.

See these sections:

- “Error Messages” (below)
- “Problems and Solutions” on page 57
- “Where To Get Help” on page 60

Error Messages

Display message	Cause and solution
Paper out -> Load paper into the sheet feeder, then press the OK button.	Load or reload paper in the sheet feeder and press the OK button to continue. See page 7 for details.
Paper jam -> Press the OK button. Remove any remaining jammed paper by hand.	See page 58 for instructions on clearing the paper jam.
[Cyan, Magenta, Yellow, Black] ink low -> Press the OK button to begin ink cartridge replacement.	Ink is low in one or more of the indicated cartridges. See page 50 for purchase and replacement instructions.
[Cyan, Magenta, Yellow, Black] ink out -> Press the OK button to begin ink cartridge replacement.	Ink is out in one or more of the indicated cartridges. See page 50 for replacement instructions.
No [Cyan, Magenta, Yellow, Black] ink cartridge -> Press the OK button to install a new ink cartridge.	An ink cartridge is not installed or is installed incorrectly. See page 50 for replacement instructions.

Display message	Cause and solution
[Cyan, Magenta, Yellow, Black] Ink cartridge error -> Cartridge replacement is necessary. Press the OK button to begin.	An ink cartridge that is not supported by the Epson Stylus CX5800F is installed. See page 50 for replacement instructions.
No memory card	A memory card is inserted that is not supported by the Epson Stylus CX5800F. Remove the incompatible memory card. See page 17 for details.
No photos on memory card	The inserted memory card does not contain any valid images. See page 16 for a list of compatible card and image types.
No index sheet detected or sheet placed incorrectly. Correct the sheet placement and try again.	An index sheet was not recognized because it is not positioned correctly. Align the top of the sheet with the left edge of the glass. See page 19 for details.
No photos selected or photos marked incorrectly. Select photos correctly and try again.	No marks are detected on the index sheet or the sheet includes more than one mark for an image. Remove the index sheet, mark it correctly, and try again. See page 19 for details.
Memory card data does not match index sheet. Replace the card or index sheet and try again.	The index sheet does not match the photos on the memory card. Remove the card and insert the one used to print the index sheet (see page 17), or place the correct index sheet on the glass (see page 19).
Fax not sent. Resend using the Start B&W button.	You sent a fax using the Start Color button to a fax machine that prints only in black and white. Send the fax again (see page 39), but press the Start B&W button. You can also select to send faxes only in black and white. See page 34 for details.
Paper thickness lever is set for envelope printing.	The paper thickness lever is set to the <input checked="" type="checkbox"/> H position. If you are printing on envelopes, press Start Color or Start B&W to continue. Otherwise, set the lever to the <input type="checkbox"/> L position.

Display message	Cause and solution
Paper thickness lever is set for printing sheets of paper.	The paper thickness lever is set to the <input type="checkbox"/> L position. If you are printing on paper sheets, press Start Color or Start B&W to continue. If you're printing on envelopes, set the lever to the <input checked="" type="checkbox"/> H position.
Service required. See your documentation for details.	An Epson Stylus CX5800F part needs to be replaced. Contact your local authorized servicer or contact Epson for a referral. See page 60 for details.
Printer error -> or Scanner error -> See your documentation and call service if necessary.	There is a problem with the Epson Stylus CX5800F. Turn it off and then back on. If the error does not clear, contact your local authorized servicer or contact Epson for a referral. See page 60 for details.

Problems and Solutions

Check the solutions below if you have trouble using your Epson Stylus CX5800F.

Copying Problems

- Make sure your original is positioned in the top left corner of the glass. Place it 0.04 inch (1 mm) from the edges to avoid cropping.
- Make sure your paper is loaded short edge first and is positioned against the right edge guide with the left edge guide against its left side. Don't load paper above the arrow mark inside the left edge guide.

Faxing Problems

- If you have problems sending a fax, make sure the phone cable is connected correctly and verify that the phone line works by connecting a phone to it. Also make sure that your recipient's fax machine is turned on and working.
- If you have problems receiving a fax, make sure paper is loaded, the phone cable is connected correctly, and the phone line works. To automatically receive faxes, make sure you see a **Y** on the first screen display. (See page 41 for details.) If you see **Receiving** on the display but nothing prints, the fax data may be too large. Tell the sender to resend the fax in smaller sections.
- If you connected the Epson Stylus CX5800F to a DSL phone line, you must install a DSL filter to the line or you won't be able to fax. Contact your DSL provider for the necessary filter.
- If your phone line has static or other noise problems, turn off the **ECM** (Error Correction Mode) setting and try faxing again. See page 34 for details.

Paper Feeding Problems

- If paper doesn't feed, remove it from the sheet feeder. Flip through the stack to separate the sheets a little. Then reload the paper against the right edge guide, and slide the left edge guide against the paper (but not too tightly). Make sure the paper is not in front of the feeder guard.
- Do not load too many sheets at once (up to 20 sheets of photo paper or 100 sheets of plain paper). See the *User's Guide* for more information.
- If paper is jammed, you see a paper jam message on the display. Follow these steps to clear the jam:
 1. Press the **OK** button to eject the jammed paper. If the jammed paper is not ejected, go to the next step.
 2. If the paper is stuck near the sheet feeder or output tray, gently pull it out.

If the paper is stuck inside the Epson Stylus CX5800F, press the **⏻** On button to turn it off. Open the scanner and remove any paper inside, including any torn pieces. Do not pull it backward however; this can damage the sheet feeder. Close the scanner, then turn the Epson Stylus CX5800F back on.

Print Quality Problems

If you have any problems with the copy or print quality, try these solutions:

- Make sure the document is placed flat against the document table glass and the Epson Stylus CX5800F is not tilted or placed on an uneven surface.
- Load the paper printable side up (usually the whiter, brighter, or glossy side).
- Make sure your paper isn't damp or curled.
- Use a support sheet with special paper or load your paper one sheet at a time. Remove sheets from the output tray as they are printed.
- Make sure the type of paper you loaded matches the paper size and paper type settings on the control panel or in your printer software. See page 29 for details.
- For the best print quality, use Epson special paper (see page 29) and genuine Epson ink cartridges (see page 50).
- Set the paper thickness lever to the L position for most paper types. If you are printing on envelopes, set the lever to the H position.
- If you notice light or dark bands across your printouts or they are too faint, you may need to clean the print head. This unclogs the nozzles so they can deliver ink properly. Run a nozzle check to see if the print head needs cleaning. See page 47 for details.
- Clean the print head. See page 48 for details.
- If you notice jagged vertical lines, you may need to align the print head. See your *User's Guide* for instructions.
- The ink cartridges may be old or low on ink. See page 50 for instructions on replacing an ink cartridge.
- If a dotted line appears in the image, clean the document table glass with a soft, dry, lint-free cloth (paper towels are not recommended), or use a small amount of glass cleaner on a soft cloth, if necessary. **Don't spray glass cleaner directly on the glass.**

Where To Get Help

Epson provides technical assistance 24 hours a day through the electronic support services and automated telephone services listed in the following table.

Service	Access
World Wide Web	From the Internet, you can reach Epson Support at http://support.epson.com . At this site, you can download drivers and other files, look at product documentation, access troubleshooting information, and receive technical advice through e-mail.
Automated Telephone Services	A variety of automated help services are available 24 hours a day, seven days a week. To use these services, you must have a touch tone telephone and call (800) 922-8911 . Your Epson SoundAdvice SM Express Code is 82710 . Use this code to quickly select the Epson Stylus CX5800F in SoundAdvice.

To speak to a technical support representative, dial:

- U.S.: (562) 276-4382, 6 AM to 6 PM, Pacific Time, Monday through Friday
- Canada: (905) 709-3839, 6 AM to 6 PM, Pacific Time, Monday through Friday

Toll or long distance charges may apply.

Before you call, please have the following information ready:

- Product name (Epson Stylus CX5800F)
- Product serial number (located on the back)
- Proof of purchase (such as a store receipt) and date of purchase
- Computer configuration
- Description of the problem

You can purchase genuine Epson ink and paper from an authorized Epson reseller. To find the nearest reseller, please call 800-GO-EPSON (800-463-7766). To purchase online, visit www.epsonstore.com (U.S. sales only). In Canada, please call (800) 463-7766 for reseller referral.

Other Software Technical Support:

Software	Telephone/Fax	Online and E-mail
ArcSoft PhotoImpression	(510) 440-9901 8:30 AM—5:30 PM, Pacific Time, Monday—Friday Fax: (510) 440-1270	www.arcsoft.com support@arcsoft.com

Notices

Important Safety Instructions

Before using your Epson Stylus CX5800F all-in-one, read and follow these safety instructions:

- Be sure to follow all warnings and instructions marked on the Epson Stylus CX5800F.
- Use only the type of power source indicated on the Epson Stylus CX5800F label.
- Use only the power cord that comes with the Epson Stylus CX5800F. Use of another cord may cause fires or shock. Do not use the cord with any other equipment.
- Place the Epson Stylus CX5800F near a wall outlet where the plug can be easily unplugged.
Placez l'imprimante près d'une prise de contact où la fiche peut être débranchée facilement.
- Do not let the power cord become damaged or frayed.
- If you use an extension cord with the Epson Stylus CX5800F, make sure the total ampere rating of the devices plugged into the extension cord does not exceed the cord's ampere rating. Also, make sure the total ampere rating of all devices plugged into the wall outlet does not exceed the wall outlet's ampere rating.
- Avoid locations that are subject to rapid changes in heat or humidity, shocks or vibrations, or dust.
- Leave enough room around the Epson Stylus CX5800F for sufficient ventilation. Do not block or cover openings in the Epson Stylus CX5800F case or insert objects through the slots.
- Do not place the Epson Stylus CX5800F near a radiator or heating vent or in direct sunlight.
- Place the Epson Stylus CX5800F on a flat, stable surface that extends beyond its base in all directions. It will not operate properly if it is tilted or at an angle.
- Make sure the back of the Epson Stylus CX5800F is at least 3.9 inches (10 cm) away from the wall.
- Do not open the scanner section while the Epson Stylus CX5800F is copying, printing, or scanning.
- Do not spill liquid on the Epson Stylus CX5800F.

- Except as specifically explained in your documentation, do not attempt to service the Epson Stylus CX5800F yourself.
- Unplug the Epson Stylus CX5800F and refer servicing to qualified service personnel under the following conditions: if the power cord or plug is damaged; if liquid has entered the product; if the product has been dropped or the case damaged; if the product does not operate normally or exhibits a distinct change in performance. Adjust only those controls that are covered by the operating instructions.
- When storing or transporting the Epson Stylus CX5800F, do not tilt it, stand it on its side, or turn it upside down; otherwise ink may leak from the cartridge.

Ink Cartridge Safety Instructions

- Keep ink cartridges out of the reach of children and do not drink the ink.
- Be careful when you handle used ink cartridges; there may be ink remaining around the ink supply port. If ink gets on your skin, wash it off with soap and water. If it gets in your eyes, flush them immediately with water.
- Do not put your hand inside the Epson Stylus CX5800F or touch any cartridges during printing.
- Install a new ink cartridge immediately after removing an empty one. Leaving cartridges uninstalled can dehydrate the print head and may prevent the Epson Stylus CX5800F from printing.
- If you remove an ink cartridge for later use, protect the ink supply area from dirt and dust and store it in the same environment as the Epson Stylus CX5800F. Note that there is a valve in the ink supply port, making covers or plugs unnecessary, but care is needed to prevent the ink from staining items that the cartridge touches. Do not touch the ink cartridge ink supply port or surrounding area.

Telephone Equipment Safety Instructions

When using telephone equipment, you should always follow basic safety precautions to reduce the risk of fire, electric shock, and personal injury, including the following:

- Do not use the Epson Stylus CX5800F near water.
- Avoid using a telephone during an electrical storm. There may be a remote risk of electric shock from lightning.
- Do not use a telephone to report a gas leak in the vicinity of the leak.

Caution:

To reduce the risk of fire, use only a No. 26 AWG or larger telecommunication line cord.

Declaration of Conformity

According to 47CFR, Part 2 and 15 for: Class B Personal Computers and Peripherals;
and/or CPU Boards and Power Supplies used with Class B Personal Computers:

We: Epson America, Inc.
Located at: MS 3-13
3840 Kilroy Airport Way
Long Beach, CA 90806
Telephone: (562) 290-5254

Declare under sole responsibility that the product identified herein, complies with 47CFR Part 2 and 15 of the FCC rules as a Class B digital device. Each product marketed is identical to the representative unit tested and found to be compliant with the standards. Records maintained continue to reflect the equipment being produced can be expected to be within the variation accepted, due to quantity production and testing on a statistical basis as required by 47CFR §2.909. Operation is subject to the following two conditions: (1) this device may not cause harmful interference, and (2) this device must accept any interference received, including interference that may cause undesired operation.

Trade Name: Epson
Type of Product: Multifunction printer
Model: C271A

ENERGY STAR Compliance

As an ENERGY STAR® Partner, Epson has determined that this product meets the ENERGY STAR guidelines for energy efficiency. The EPA ENERGY STAR office equipment program is a voluntary partnership with the computer and office equipment industry to promote the introduction of energy-efficient personal computers, monitors, printers, fax machines, and copiers in an effort to reduce air pollution caused by power generation.



FCC Compliance Statement

For United States Users

This equipment complies with **Part 68 of the FCC rules**. On the back side is a label that contains, among other information, the FCC registration number and the **ringer equivalence number (REN)** for this equipment. You must, upon request, provide this information to your local telephone company. The information associated with the services the equipment is to be connected are REN: **BKMOT00BC271A**, Jack type: **RJ11**.

The REN is useful to determine the quantity of devices that you may connect to your telephone line and still have all of those devices ring when your telephone number is called. In most, but not all areas, the sum of the RENs of all devices connected to one line should not exceed five (5.0). To be certain of the number of devices that you may connect to your line, you may want to contact your local telephone company to determine the maximum REN for your calling area. For products approved after July 23, 2001, the REN for this product is part of the product identifier that has the format US: BKMOT00C271A. The digits represented by 00 are the REN without a decimal point (e.g., 00 is a REN of 0.0). For earlier products, the REN is separately shown on the label.

This equipment may not be used on coin service provided by the telephone company. Connection to party lines is subject to state tariffs.

Should this equipment cause harm to the telephone network, the telephone company may discontinue your service temporarily. If possible they will notify you in advance that temporary discontinuance of service may be required. But if advanced notice isn't practical, the telephone company will notify you as soon as possible. You will be informed of your right to file a complaint with the FCC. The telephone company may make changes in its facilities, equipment, operations or procedures that could affect the proper functioning of your equipment. If they do, you will be notified in advance to give you an opportunity to maintain uninterrupted telephone service.

This product is not intended to be repaired. If you experience trouble with this equipment, please contact:

Name: Epson America, Inc.
Address: 3840 Kilroy Airport Way, Long Beach, CA 90806 U.S.A.
Telephone: 1-562-981-3840

The telephone company may ask that you disconnect this equipment from the network until the problem has been corrected or until you are sure that the equipment is not malfunctioning.

A plug and jack used to connect this equipment to the premises wiring and telephone network must comply with the applicable FCC Part 68 rules and requirements adopted by the ACTA. A compliant telephone cord and modular plug is provided with this product. It is designed to be connected to a compatible modular jack that is also compliant. See installation instructions for details.

The Telephone Consumer Protection Act of 1991 makes it unlawful for any person to use a computer or other electronic device, including fax machines, to send any message unless such message clearly contains in a margin at the top or bottom of each transmitted page or on the first page of the transmission, the date and time it is sent and an identification of the business or other entity, or other individual sending the message and the telephone number of the sending machine or such business, other entity, or individual. In order to program this information into your fax machine, follow the instructions in “Creating Header Information” on page 32.

According to the FCC’s electrical safety advisory, we recommend that you may install an AC surge arrestor in the AC outlet to which this equipment is connected. Telephone companies report that electrical surges, typically lightning transients, are very destructive to customer terminal equipment connected to AC power sources and that this is a major nationwide problem.

If your home has specially wired alarm equipment connected to the telephone line, ensure the installation of this equipment Model C271A does not disable your alarm equipment. If you have questions about what will disable alarm equipment, consult your telephone company or a qualified installer.

This equipment has been tested and found to comply with the limits for a Class B digital device, pursuant to Part 15 of the FCC Rules. These limits are designed to provide reasonable protection against harmful interference in a residential installation. This equipment generates, uses, and can radiate radio frequency energy and, if not installed and used in accordance with the instructions, may cause harmful interference to radio or television reception. However, there is no guarantee that interference will not occur in a particular installation. If this equipment does cause interference to radio and television reception, which can be determined by turning the equipment off and on, the user is encouraged to try to correct the interference by one or more of the following measures:

- Reorient or relocate the receiving antenna.
- Increase the separation between the equipment and receiver.
- Connect the equipment into an outlet on a circuit different from that to which the receiver is connected.
- Consult the dealer or an experienced radio/TV technician for help.

WARNING

The connection of a non-shielded equipment interface cable to this equipment will invalidate the FCC Certification of this device and may cause interference levels which exceed the limits established by the FCC for this equipment. It is the responsibility of the user to obtain and use a shielded equipment interface cable with this device. If this equipment has more than one interface connector, do not leave cables connected to unused interfaces. Changes or modifications not expressly approved by the manufacturer could void the user's authority to operate the equipment.

For Canadian Users

1. This product meets the applicable Industry Canada technical specifications.

Le présent matériel est conforme aux spécifications techniques applicables d'Industrie Canada.

2. The Ringer Equivalence Number is an indication of the maximum number of devices allowed to be connected to a telephone interface. The termination on an interface may consist of any combination of devices subject only to the requirement that the sum of the RENs of all the devices does not exceed five.

L'indice d'équivalence de la sonnerie (IES) sert à indiquer le nombre maximal de terminaux qui peuvent être raccordés à une interface téléphonique. La terminaison d'une interface peut consister en une combinaison quelconque de dispositifs, à la seule condition que la somme d'indices d'équivalence de la sonnerie de tous les dispositifs n'excède pas 5.

This Class B digital apparatus complies with Canadian ICES-003.

Cet appareil numérique de la classe B est conforme à la norme NMB-003 du Canada.

Epson America, Inc., Limited Warranty

What Is Covered: Epson America, Inc. (“Epson”) warrants to the original retail purchaser that the Epson printer covered by this limited warranty statement, if purchased and operated only in the United States or Canada, conforms to the manufacturer’s specifications and will be free from defects in workmanship and materials for a period of one (1) year from the date of original purchase. For warranty service, you must provide proof of the date of original purchase.

What Epson Will Do To Correct Problems: Should your Epson printer prove defective during the warranty period, please call the Epson ConnectionSM at (562) 276-4382 (U.S.) or (905) 709-3839 (Canada) for warranty repair instructions and return authorization. An Epson service technician will provide telephone diagnostic service to determine whether the printer requires service. If service is needed, Epson will, at its option, exchange or repair the printer without charge for parts or labor. If Epson authorizes an exchange for the defective unit, Epson will ship a replacement printer to you, freight prepaid, so long as you use an address in Canada or the U.S. (excluding Puerto Rico and U.S. Possessions). Shipments to other locations will be made freight collect. You are responsible for securely packaging the defective unit and returning it to Epson within five (5) working days of receipt of the replacement. Epson requires a debit or a credit card number to secure the cost of the replacement printer in the event that you fail to return the defective one. If your printer is being repaired, Epson will direct you to send your printer to Epson or its authorized service center, where the printer will be fixed and sent back to you. You are responsible for packing the printer and for all costs to and from the Epson authorized service center. When warranty service involves the exchange of the printer or a part, the item replaced becomes Epson property. The replacement printer or part may be new or refurbished to the Epson standard of quality, and, at Epson’s option, may be another model of like kind and quality. Epson’s liability for replacement of the covered printer will not exceed the original retail selling price of the covered printer. Exchange products and parts assume the remaining warranty period of your original product covered by this limited warranty.

What This Warranty Does Not Cover: This warranty does not apply to refurbished or reconditioned products. This warranty covers only normal use in the United States and Canada. Using this product for continuous production or similar high duty purposes is not considered normal use; damage, maintenance or service from such use will not be covered under this warranty. This warranty is not transferable. This warranty does not cover any color change or fading of prints or reimbursement of materials or services required for reprinting. This warranty does not cover damage to the Epson product caused by parts or supplies not manufactured, distributed or certified by Epson. This warranty does not cover ribbons, ink cartridges or third party parts, components, or peripheral devices added to the Epson product after its shipment from Epson, e.g., dealer or user-added boards or components. Epson is not responsible for warranty service should the

Epson label or logo or the rating label or serial number be removed or should the product fail to be properly maintained or fail to function properly as a result of misuse, abuse, improper installation, neglect, improper shipping, damage caused by disasters such as fire, flood, and lightning, improper electrical current, software problems, interaction with non-Epson products, or service other than by an Epson Authorized Servicer. If a claimed defect cannot be identified or reproduced, you will be held responsible for the costs incurred.

THE WARRANTY AND REMEDY PROVIDED ABOVE ARE EXCLUSIVE AND IN LIEU OF ALL OTHER EXPRESS OR IMPLIED WARRANTIES INCLUDING, BUT NOT LIMITED TO, THE IMPLIED WARRANTIES OF MERCHANTABILITY, NON-INFRINGEMENT OR FITNESS FOR A PARTICULAR PURPOSE. SOME LAWS DO NOT ALLOW THE EXCLUSION OF IMPLIED WARRANTIES. IF THESE LAWS APPLY, THEN ALL EXPRESS AND IMPLIED WARRANTIES ARE LIMITED TO THE WARRANTY PERIOD IDENTIFIED ABOVE. UNLESS STATED HEREIN, ANY STATEMENT OR REPRESENTATIONS MADE BY ANY OTHER PERSON OR FIRM ARE VOID. EXCEPT AS PROVIDED IN THIS WRITTEN WARRANTY, NEITHER EPSON AMERICA, INC. NOR ITS AFFILIATES SHALL BE LIABLE FOR ANY LOSS, INCONVENIENCE, OR DAMAGE, INCLUDING DIRECT, SPECIAL, INCIDENTAL OR CONSEQUENTIAL DAMAGES, RESULTING FROM THE USE OR INABILITY TO USE THE EPSON PRODUCT, WHETHER RESULTING FROM BREACH OF WARRANTY OR ANY OTHER LEGAL THEORY.

In Canada, warranties include both warranties and conditions.

Some jurisdictions do not allow limitations on how long an implied warranty lasts, and some jurisdictions do not allow the exclusion or limitation of incidental or consequential damages, so the above limitations and exclusions may not apply to you. This warranty gives you specific legal rights and you may have other rights which vary from jurisdiction to jurisdiction.

To find the Epson Authorized Reseller nearest you, visit our website at: <http://www.epson.com>.

To find the Epson Customer Care Center nearest you, visit <http://support.epson.com>.

You can also write to:

Epson America, Inc., P.O. Box 93012, Long Beach, CA 90809-3012

Index

A

- Answer mode, fax, 41 to 42
- Answering machine, connecting, 31
- ArcSoft PhotoImpression, 43, 60

B

- Borderless
 - copies, 12
 - printing, Macintosh, 26 to 27
 - printing, Windows, 24

C

- Camera, printing from, 22
- Cleaning
 - document table glass, 59
 - print head, 48 to 49
- Color Management, turning off, 25, 27
- Color, restoring while scanning, 45
- ColorSync, 27
- Copying
 - documents, 11
 - photos, 12
 - placing originals, 9 to 10
 - problems, 57
 - speeding up, 13

D

- Date setting, 32 to 33
- Declaration of Conformity, 63
- Digital camera, printing from, 22
- Display messages, 55 to 57
- DPOF printing, 21
- Draft mode, copying in, 13
- DSL, 58

E

- ENERGY STAR, 63
- EPSON Scan, 43 to 45
- Error messages, 55 to 57

F

- Faxing
 - answer mode, 41 to 42
 - connecting for, 31
 - creating header, 32 to 33
 - paper size setting, 33 to 35
 - problems, 58
 - receiving, 41 to 42
 - redialing, 39 to 40
 - send/receive settings, 34 to 36, 58
 - sending manually, 39 to 40
 - speed dialing, *see* Speed dial
- FCC statement, 64 to 66
- Formats, image, 16

H

Head Cleaning utility, 48 to 49
Help, 60

I

Image formats, 16
Image quality problems, 59
Index sheet
 printing, 18 to 19
 selecting/scanning photos from, 19 to 20
Ink cartridge
 level check, 49
 part numbers, 50
 problems, 59
 replacing, 50 to 53
 safety instructions, 62
Introduction, 5

M

Macintosh, printing from, 26 to 28
Maintenance, 47 to 53
Media Type settings, 29
Memory cards
 compatible, 16
 inserting, 17 to 18
 printing from, 18 to 21
 removing, 18
Messages, display, 55 to 57

N

Nozzle Check utility, 47 to 48

P

Paper
 jams, 55, 58
 loading, 7 to 8
 type settings, 29
Paper thickness lever, 8, 56, 59
PictBridge camera, printing from, 22
Print head
 checking nozzles, 47 to 48
 cleaning, 48 to 49
Printing
 from camera, 22
 from computer, 23 to 29
 from memory card, 15 to 21
Problems, solving
 copying, 57
 error messages, 55 to 57
 faxing, 58
 help, 60
 paper feeding, 58
 print quality, 59

S

Safety instructions, 61 to 62
Scanning
 basic, 43 to 44
 placing originals, 43 to 44
 restoring color, 45
Service, 60
Speed dial
 dialing from list, 40 to 41
 printing list, 38
 setting up list, 36 to 38
Support, 60

T

Technical support, 60

Telephone

connecting, 31

safety instructions, 62

Time setting, 32 to 33

Troubleshooting, 55 to 60

U

USB DIRECT-PRINT camera, printing

from, 22

W

Warranty, 67 to 68

Windows, printing with, 23 to 25

EPSON[®]
EXCEED YOUR VISION



410416100

CPD-20213R1
Printed in XXXXXX XX.XX-XX XXX